

DIUNA KOM 193 4D

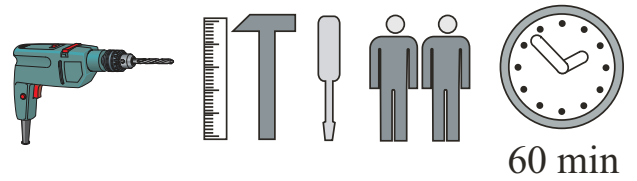

NO	Dim.			Col.-No	Qty
1	708	400	16	2	1
2	708	400	16	2	1
3	1926	400	16	1	1
4	1926	400	16	1	1
5	708	380	16	2	3
6	457	370	16	2	2
7	465	370	16	2	2
8	750	477	16	3	4
9	720	472	3	3	2
10	720	479	3	3	2

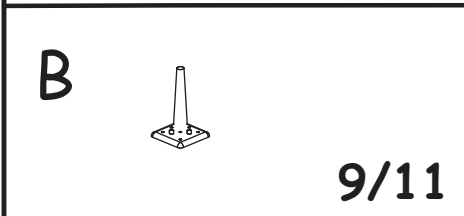
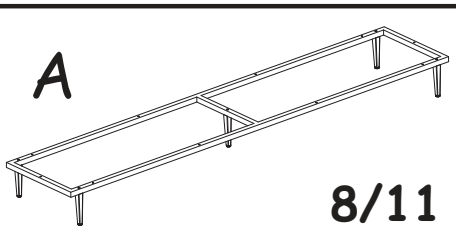
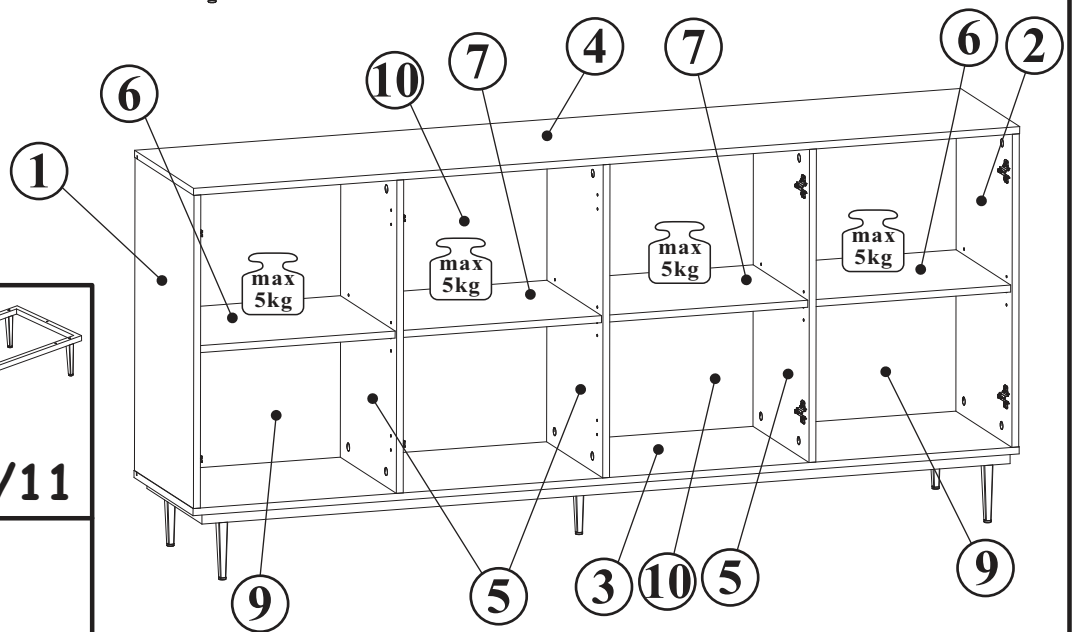
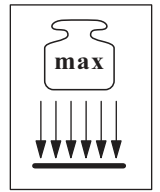
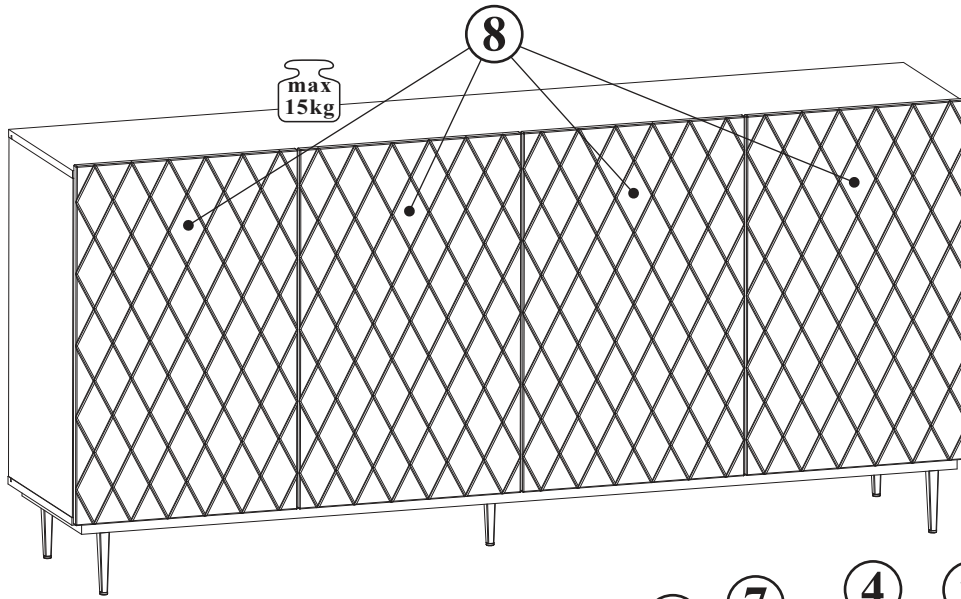
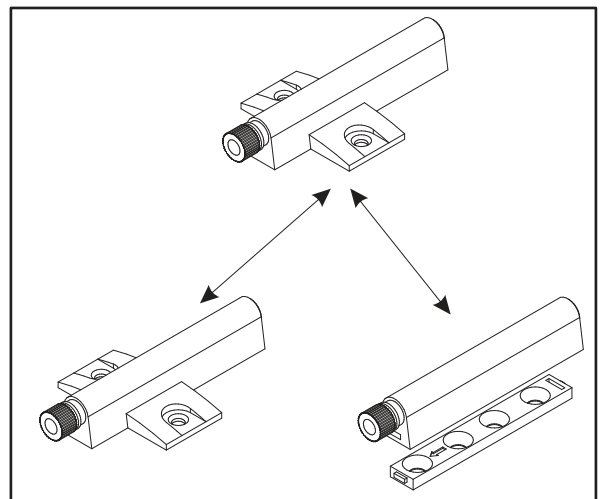
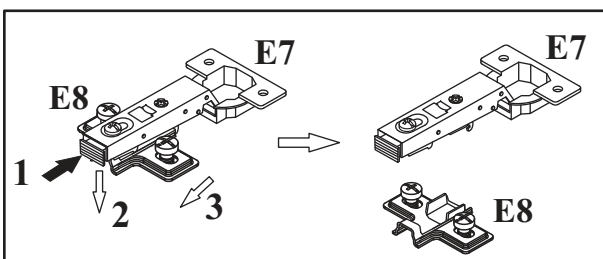
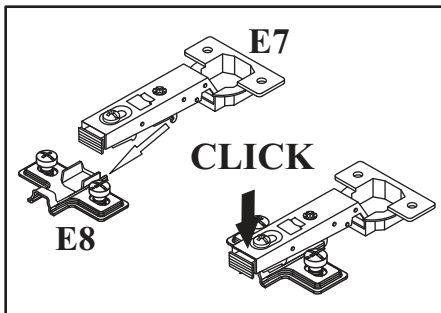
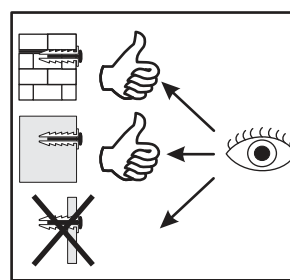
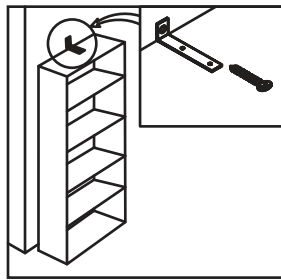
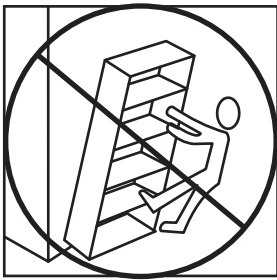
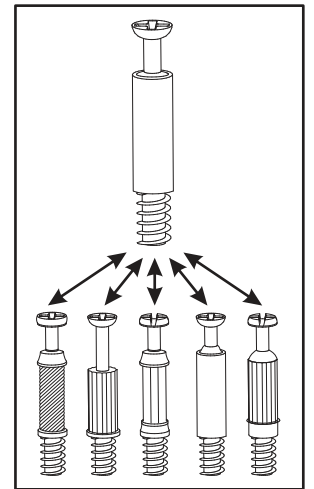
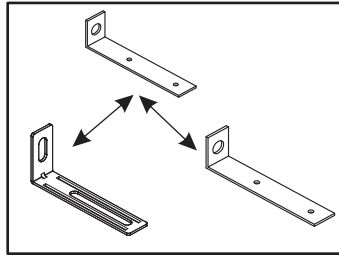
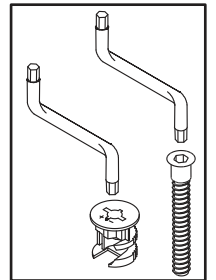
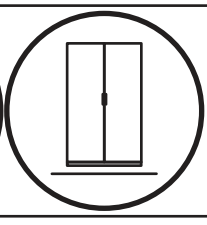
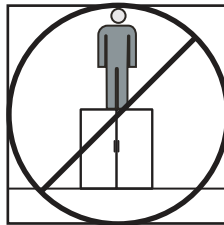
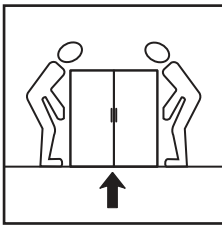
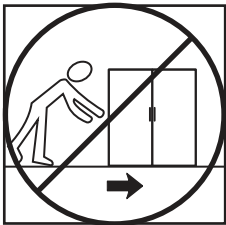
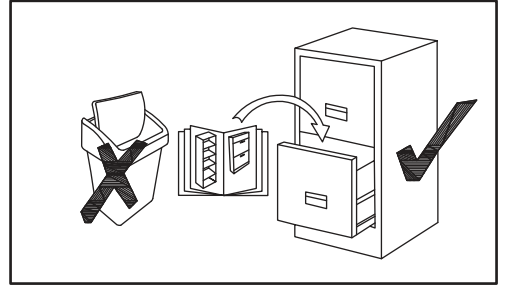
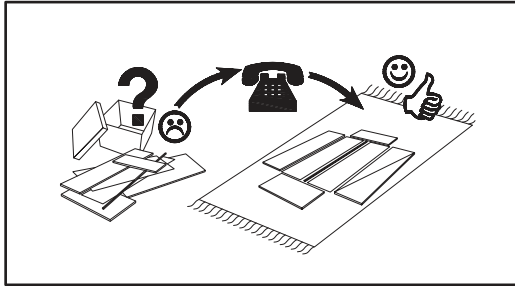
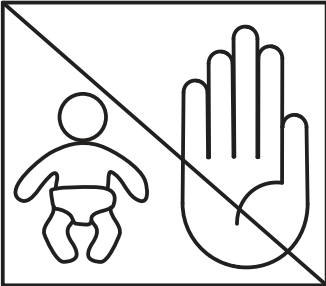
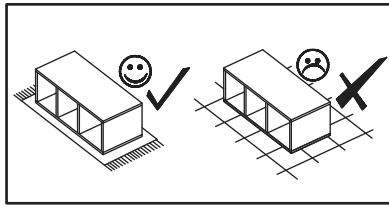
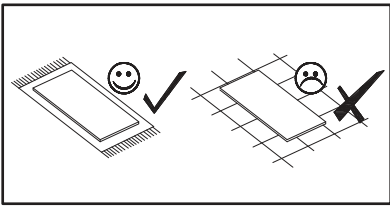

DIUNA KOM 193 4D

A1 x20 ø8x36		B4 x20		B5 x20 ø15x12		G5 x20		G7 x16		D10 x20 USØ3,5x13	
E7 x4 Ø35 CD H=0		E9 x4 Ø35 CD H=8		Z2 x16 ø5		G16 x15		L1 x2		KR1 x2	
E28 x8 CD H=0		S1 x22		UP13 x15 UPØ3x16		G2 x1					

A

Z6
x1

MØ6x25
x5

USØ3,5x30
x10

x1

B

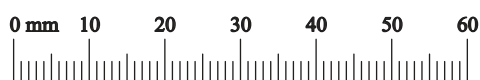

USØ3,5x20
x20

JO-1
x5



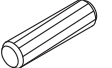
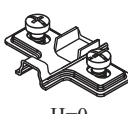

DIUNA KOM 193 4D

1

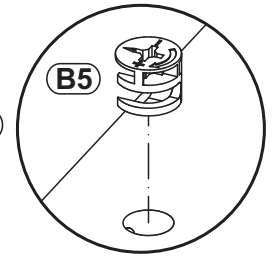
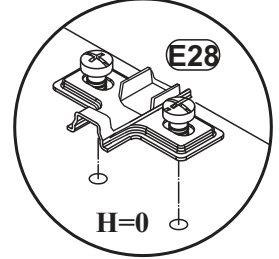
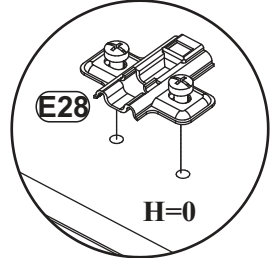
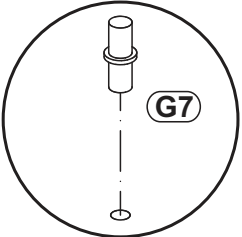
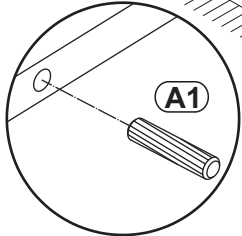
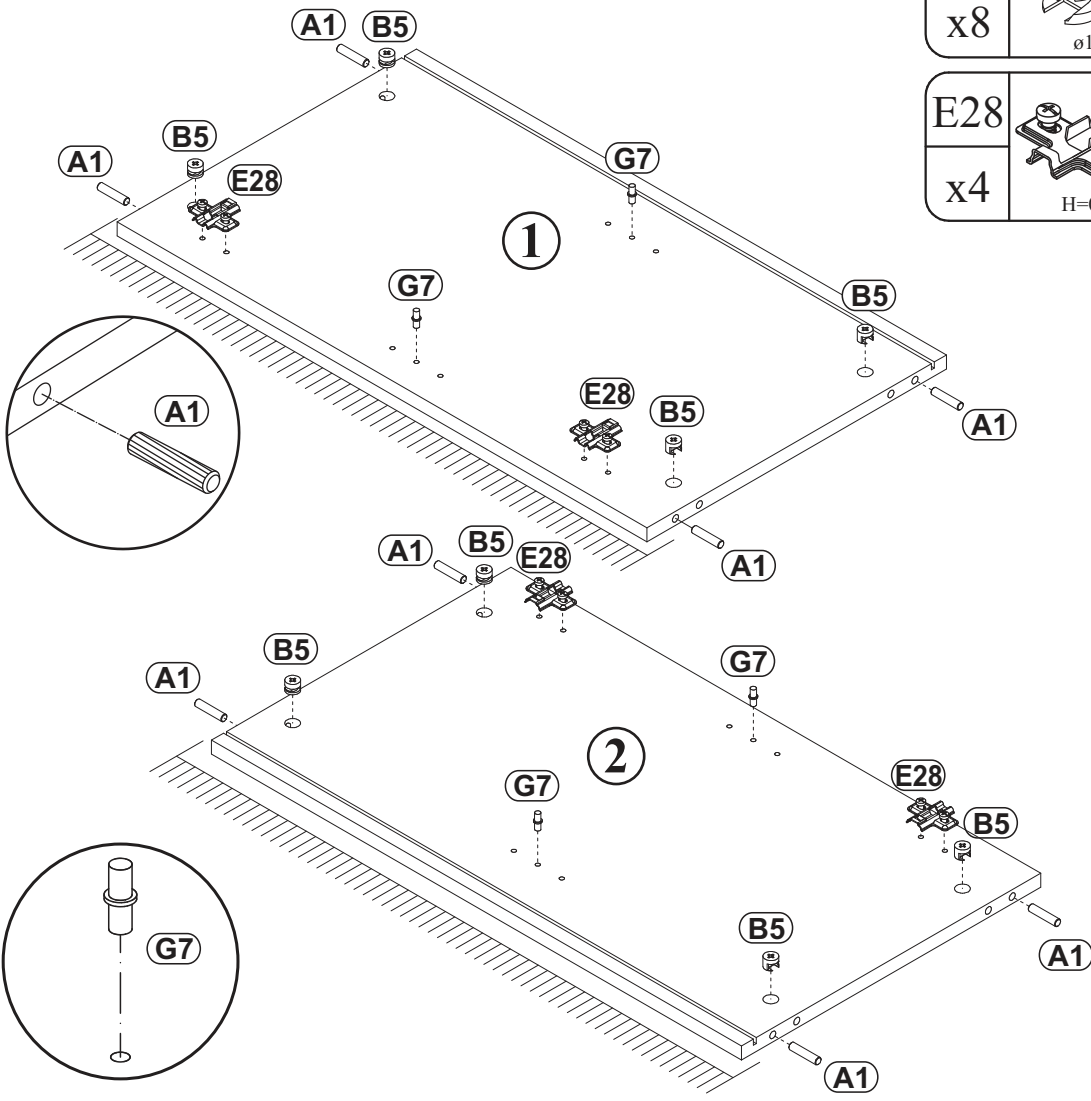
B5		A1	
x8	ø15x12	x8	ø8x36
E28		G7	
x4	H=0	x4	

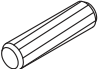

2

B5		A1	
x12	ø15x12	x12	ø8x36
G7			
x12			

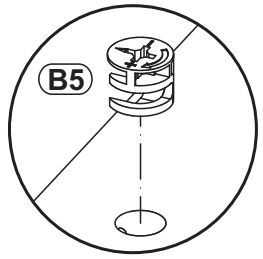
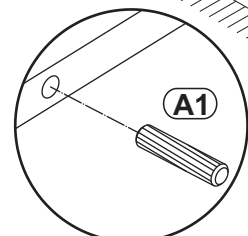
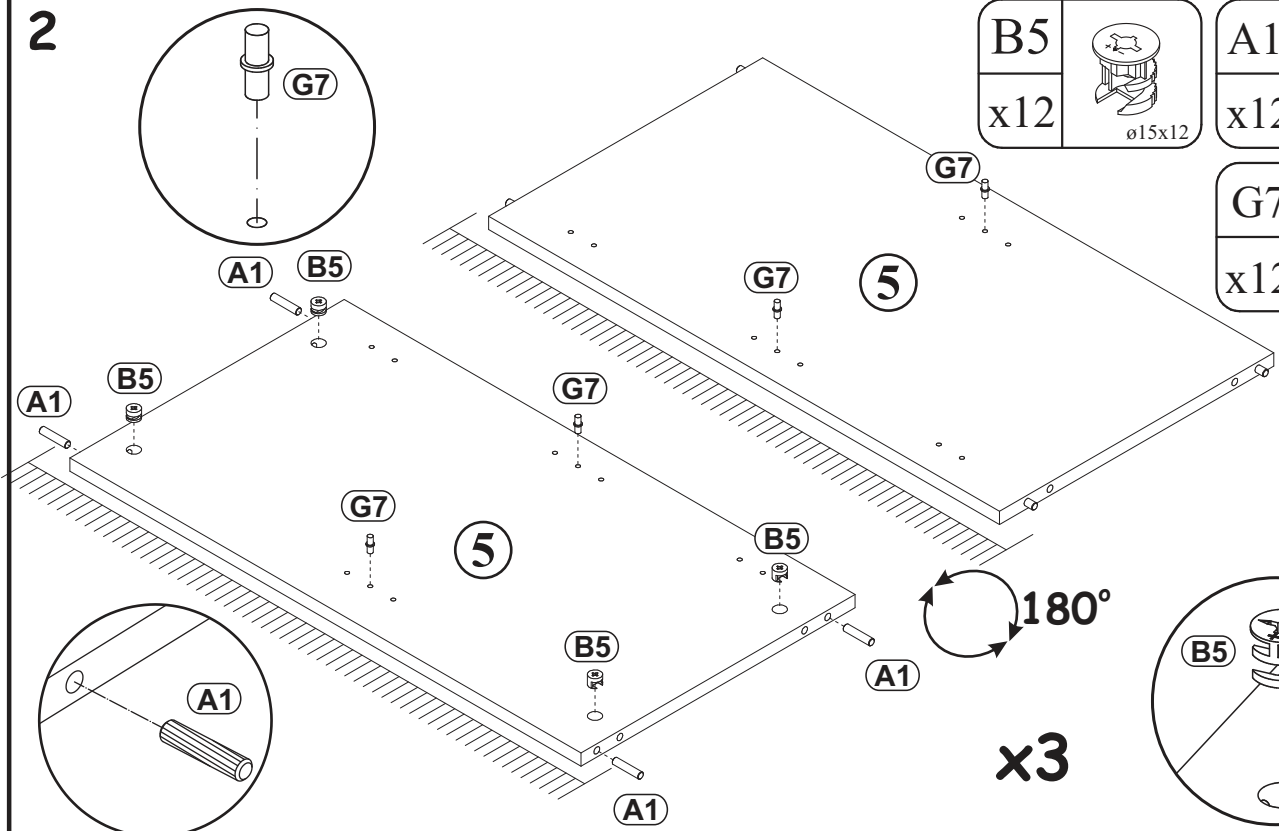

180°
x3

DIUNA KOM 193 4D

3

E7

E7	Ø35 CD
x4	H=0

E9	Ø35 CD
x4	H=8

D10	
x16	USØ3,5x13

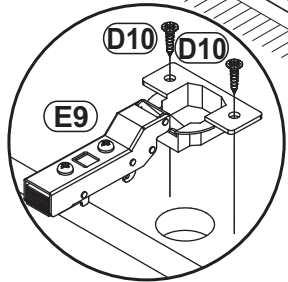
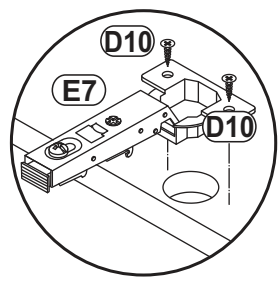
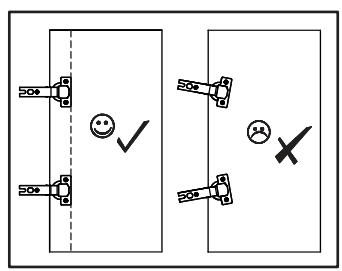
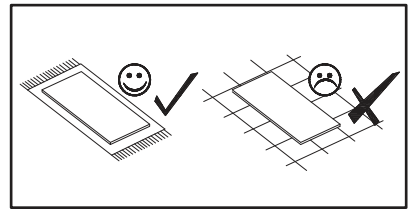
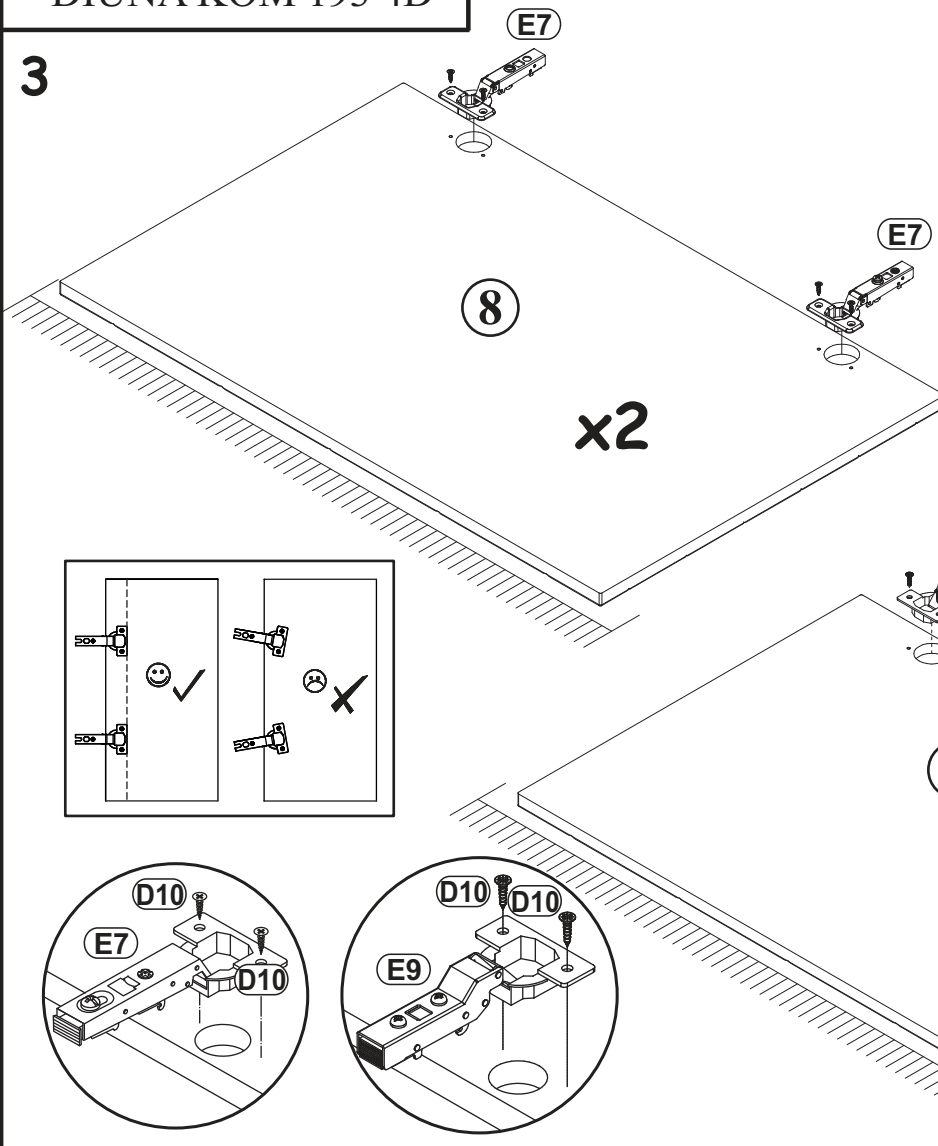

4

B4	
x20	

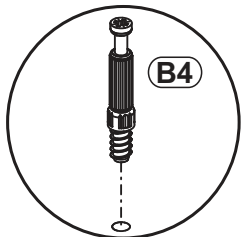
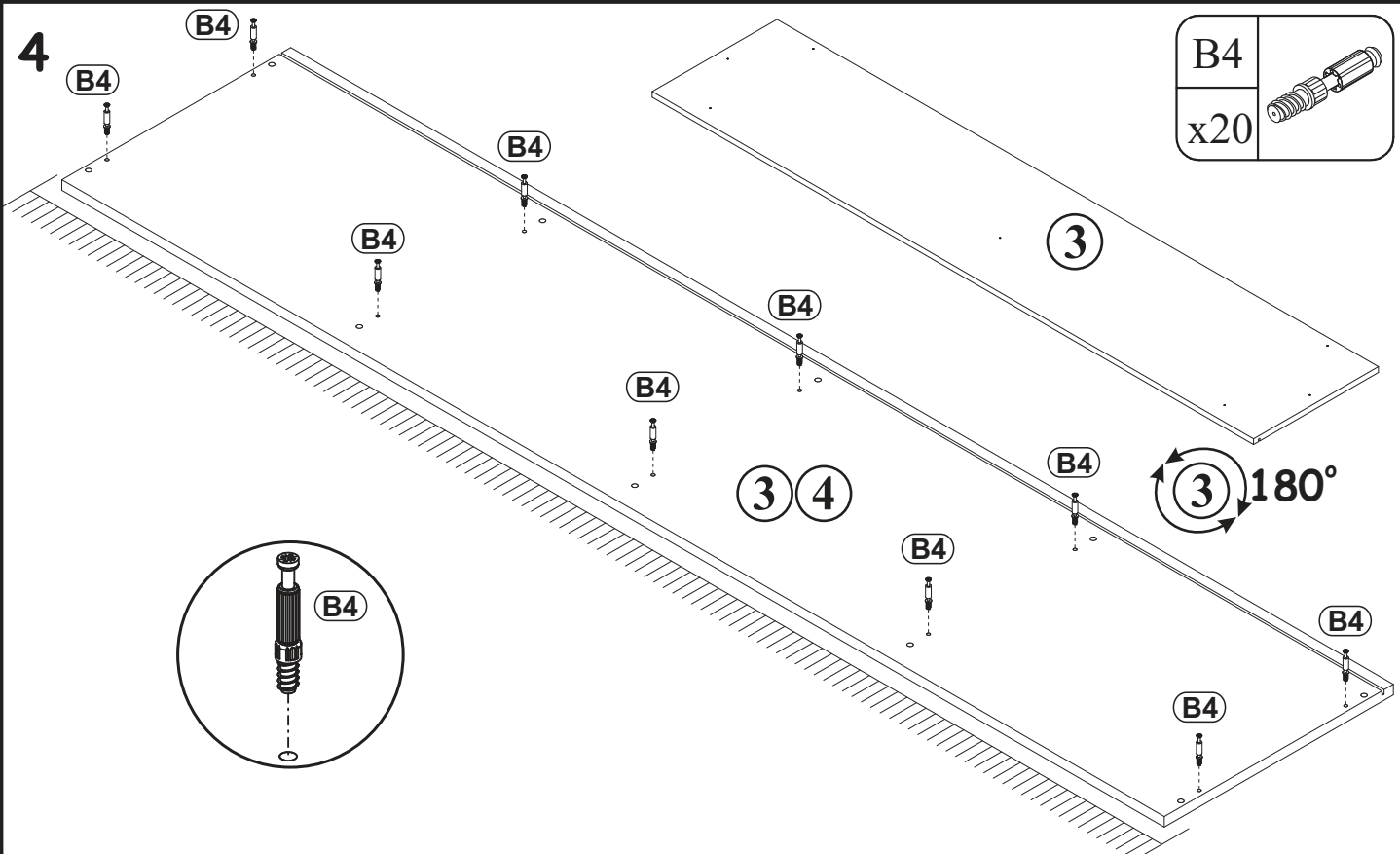

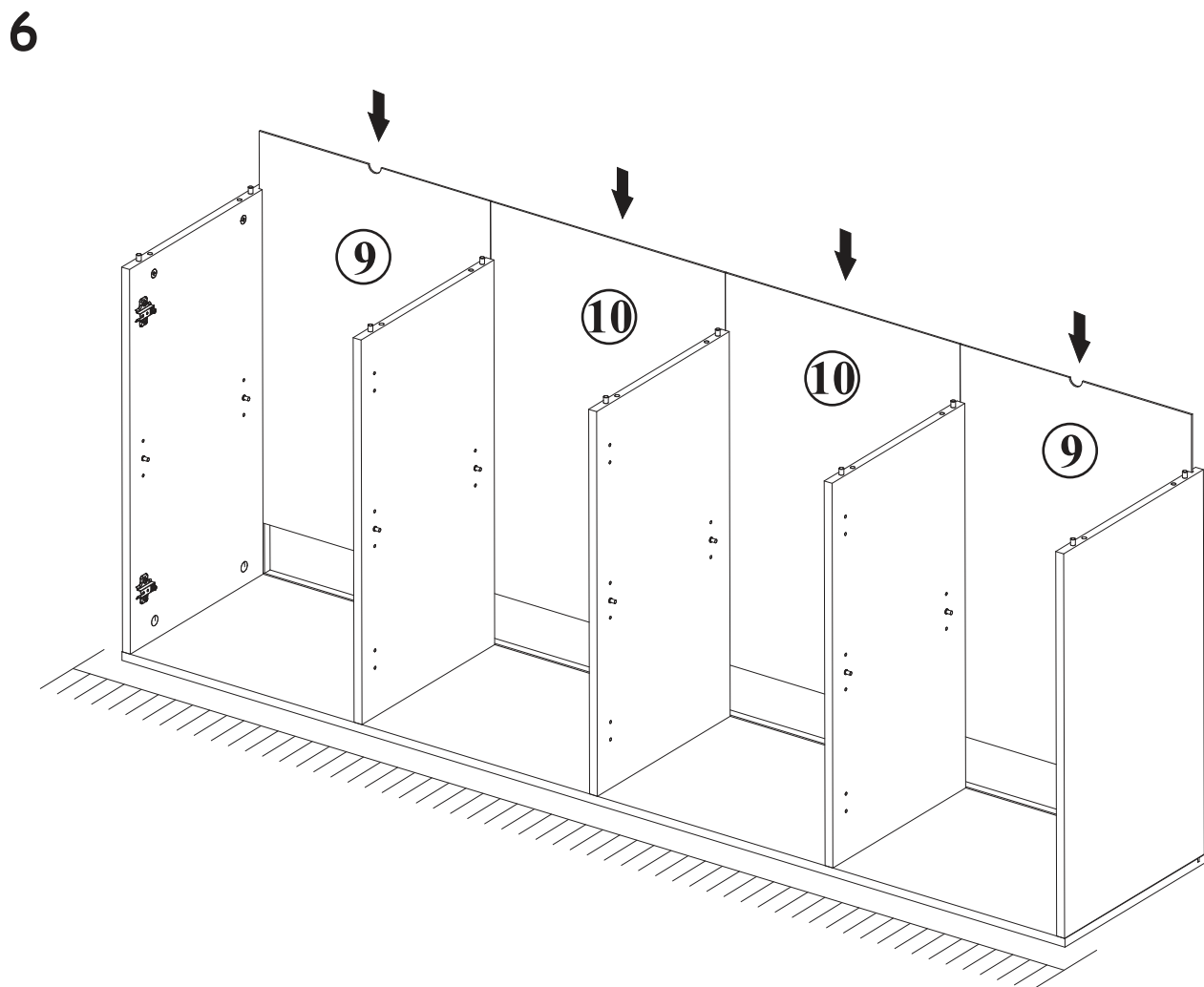
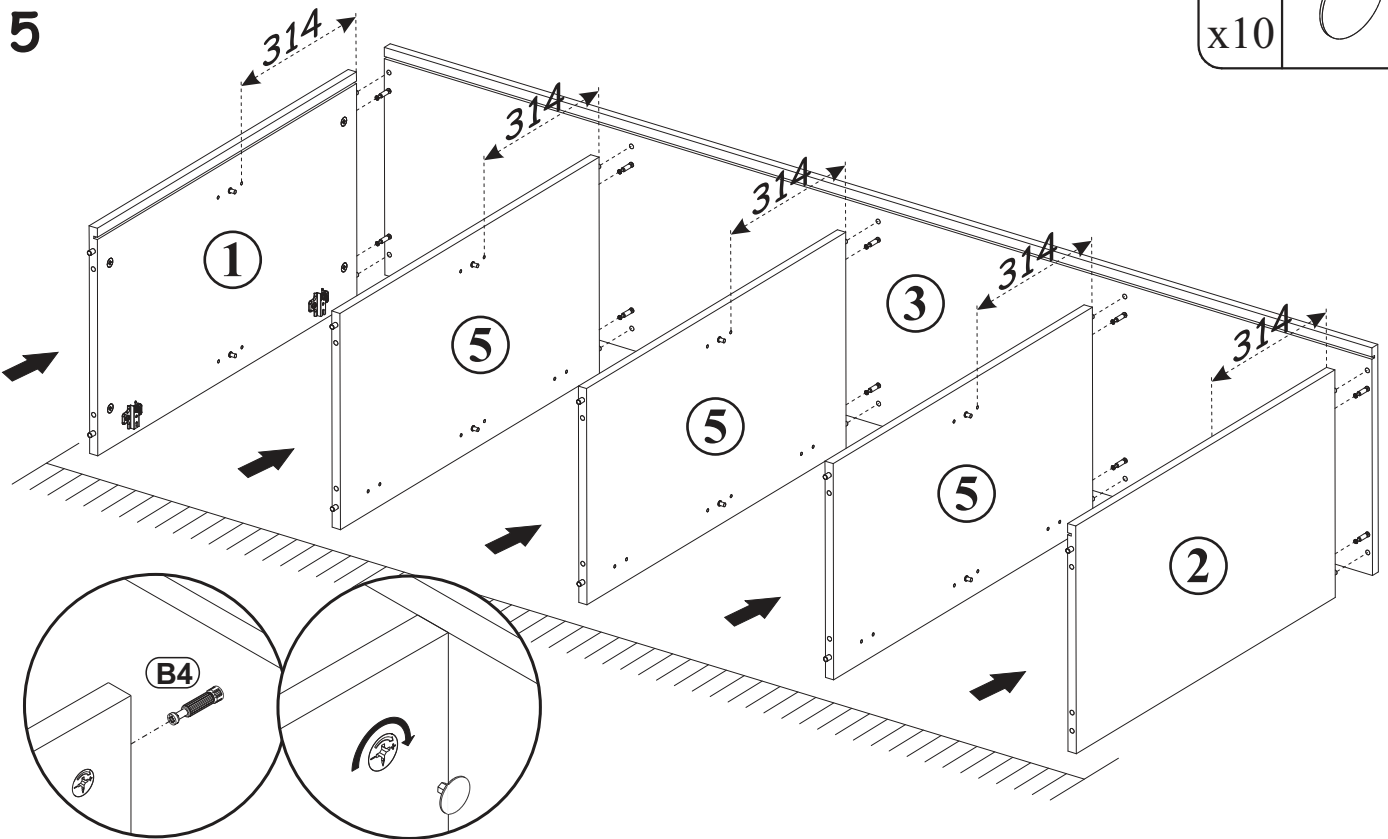

G5	
x10	

7

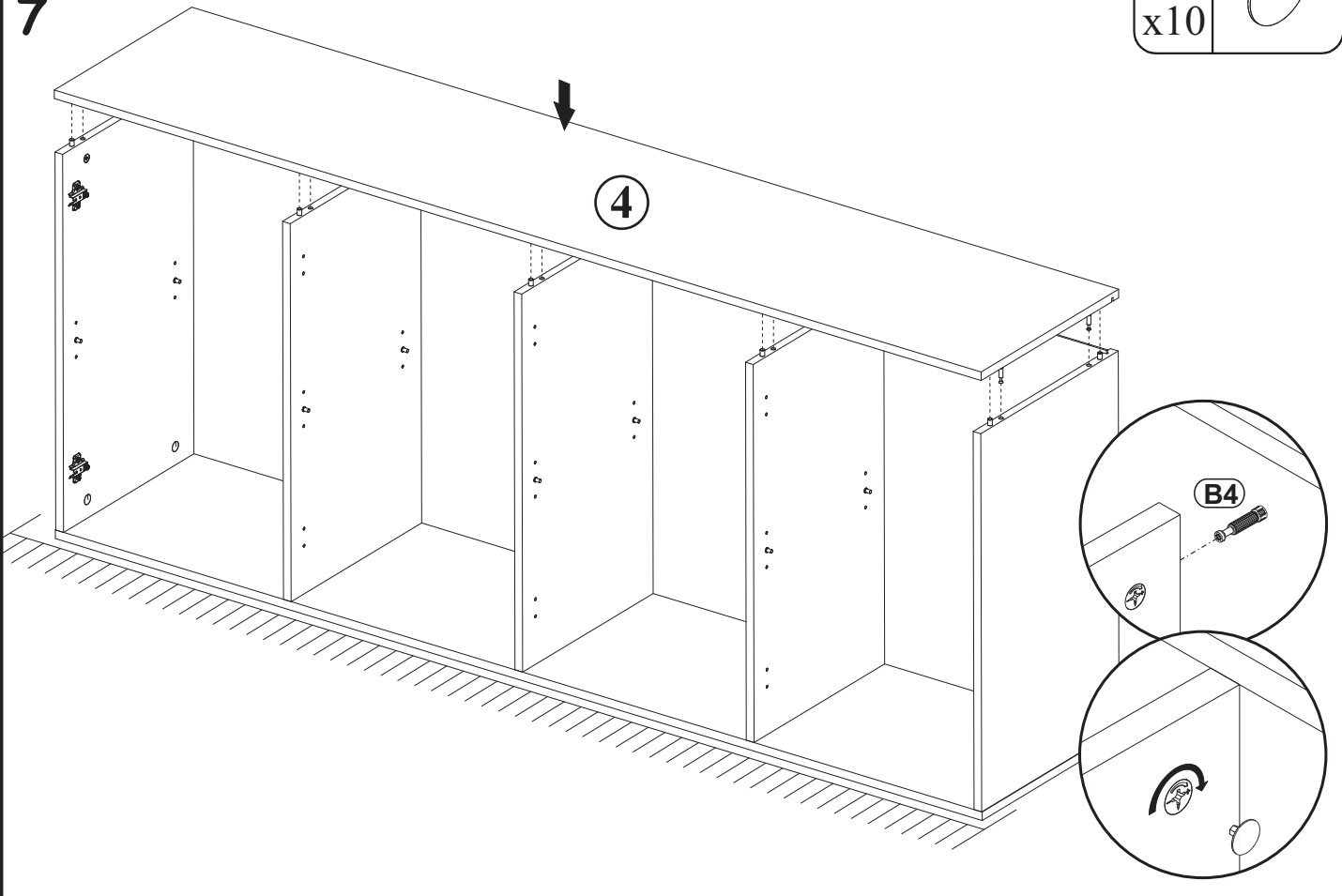

8

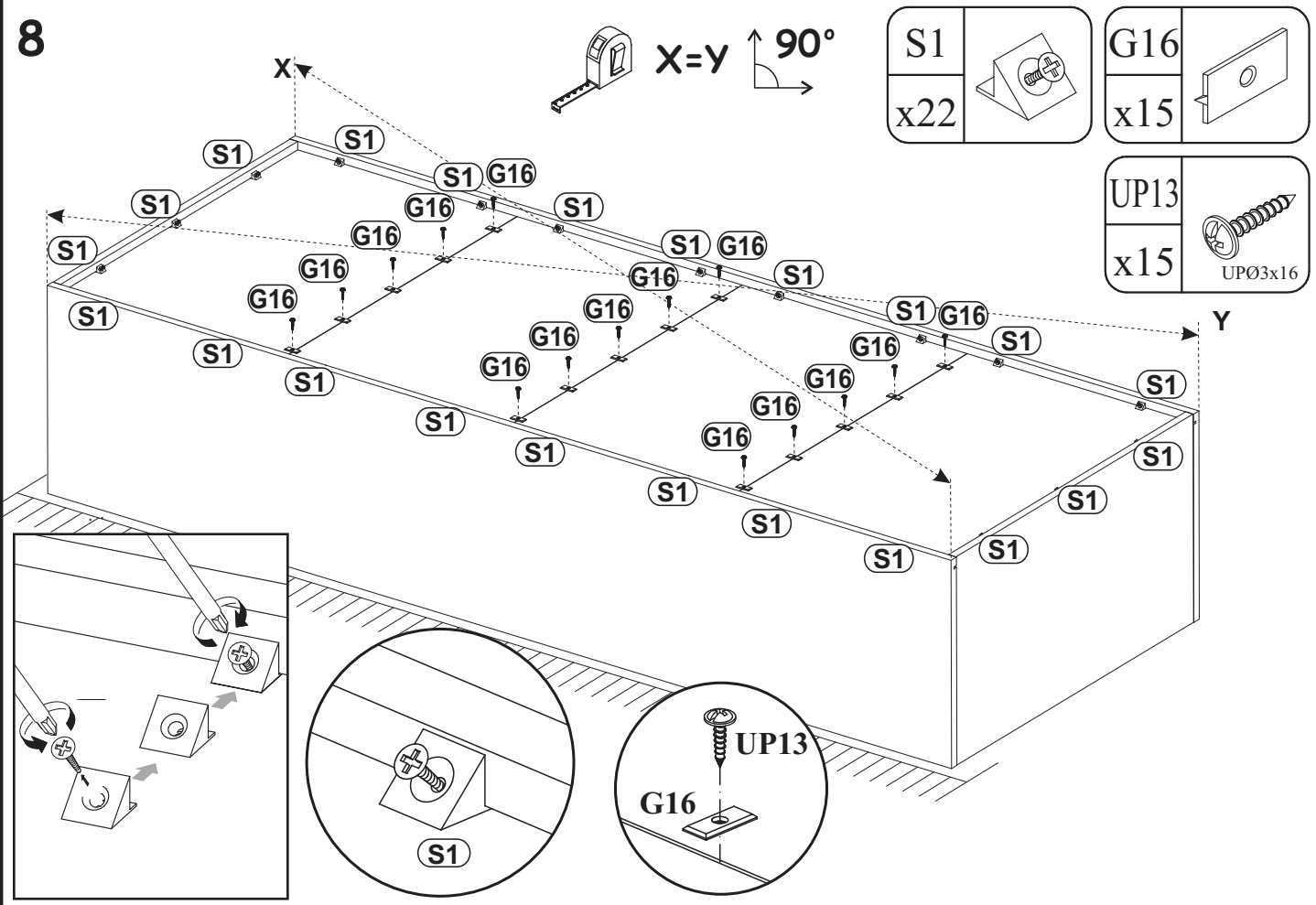

10

B
USØ3,5x20
x20

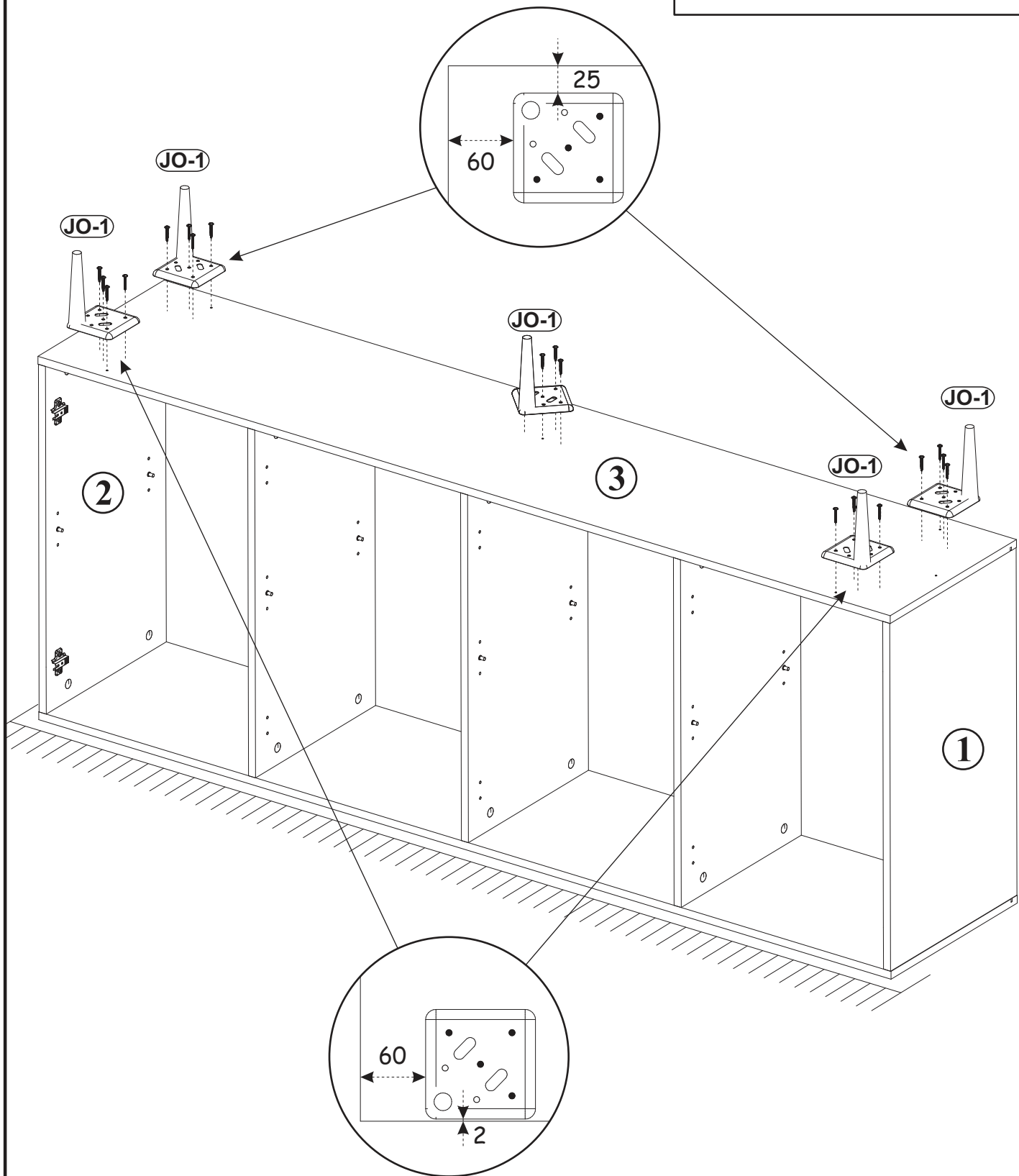
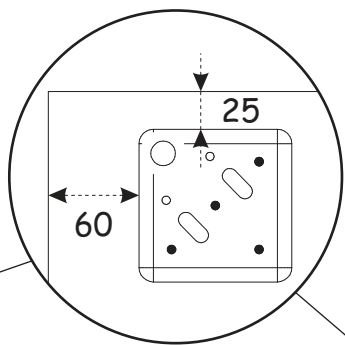
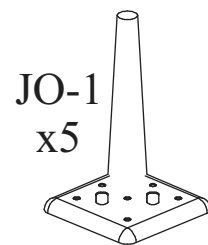

11

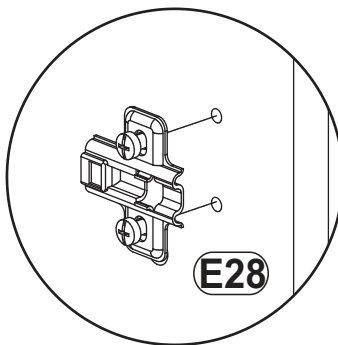
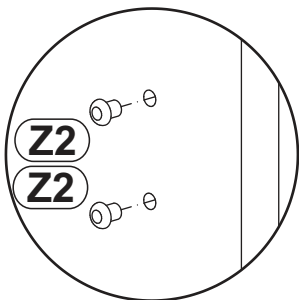
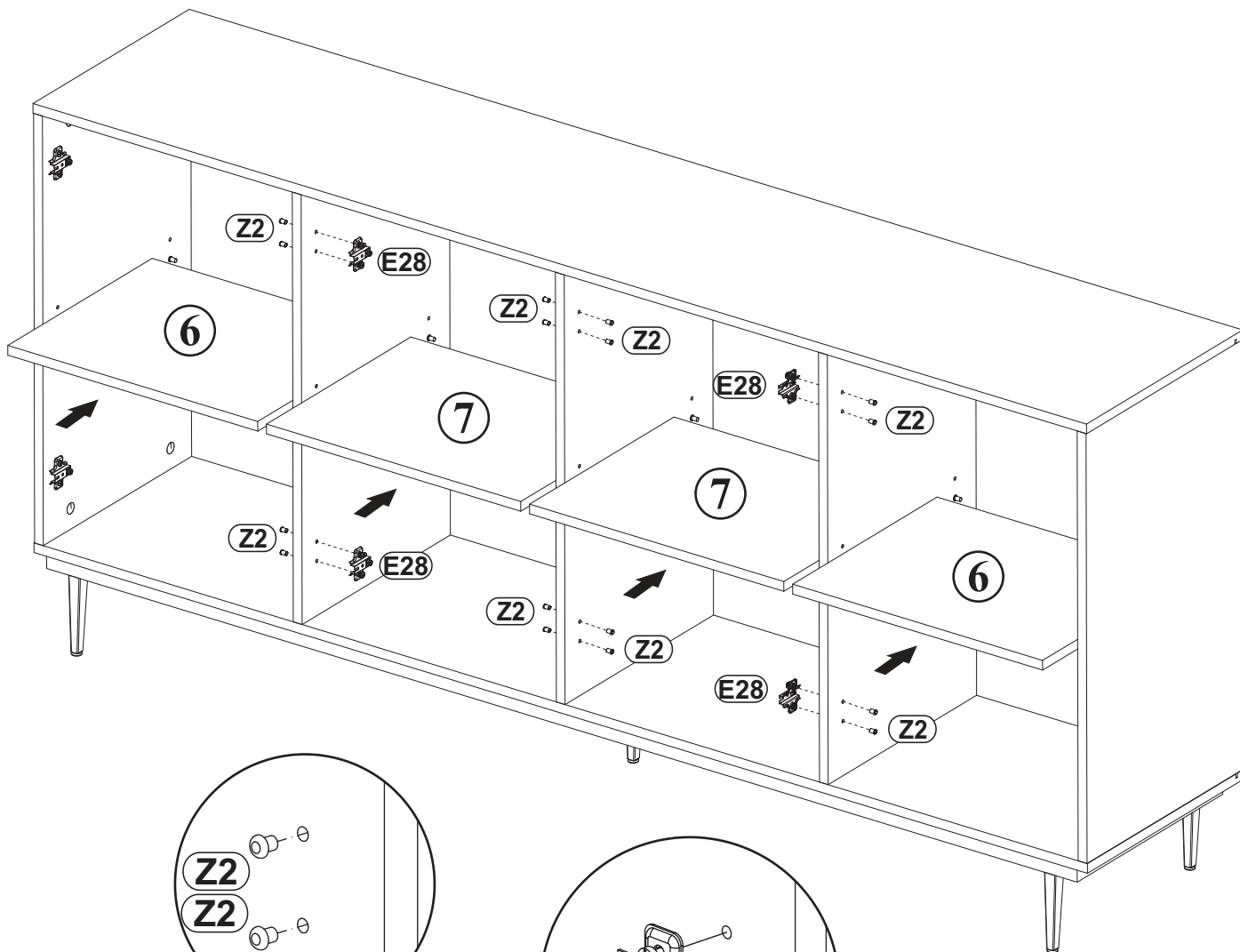
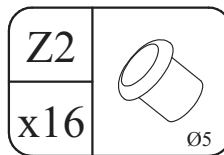
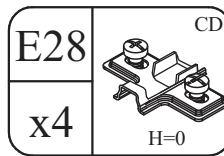

12

