

# RAVENNA COFFEE TABLE CARB

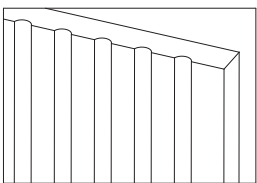

Ravenna -B

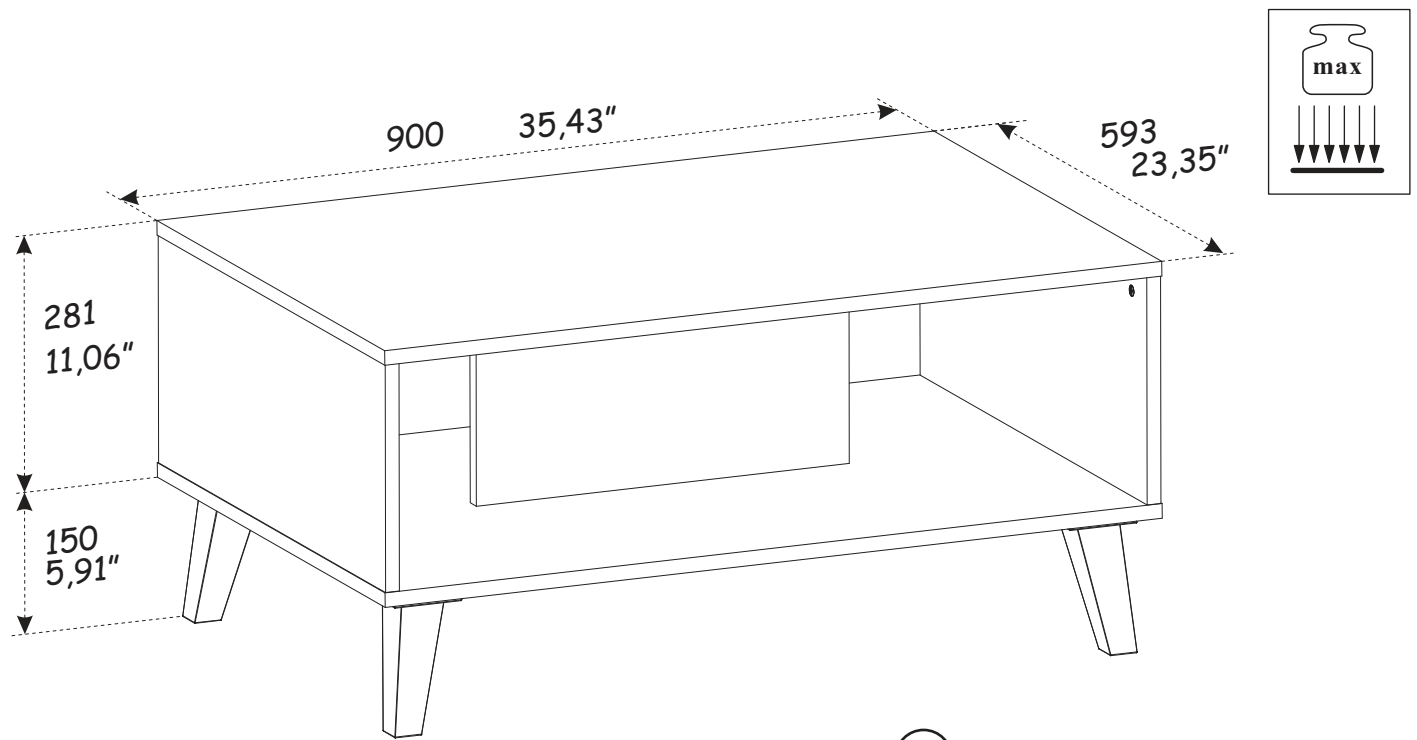
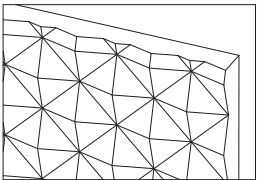

Ravenna -C  
DIAMOND

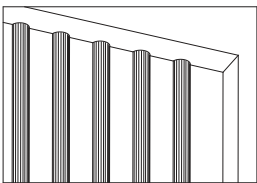

Ravenna -F

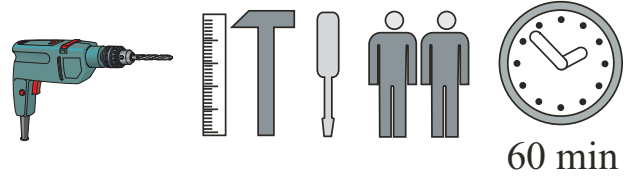
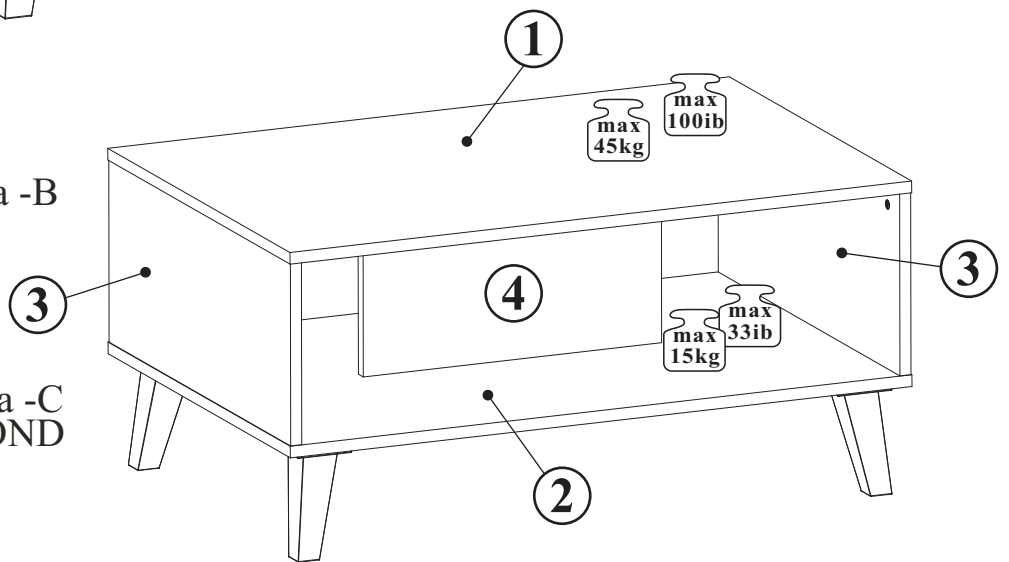

NO	Dim. [mm]		Col.-No	Qty
1	900	593	16	1
2	900	593	16	1
3	249	591	16	2
4	432	249	16	1

NO	Dim. [in]		Col.-No	Qty
1	35,43	23,35	0,63	1
2	35,43	23,35	0,63	1
3	9,80	23,27	0,63	2
4	17,01	9,80	0,63	1

# RAVENNA COFFEE TABLE CARB

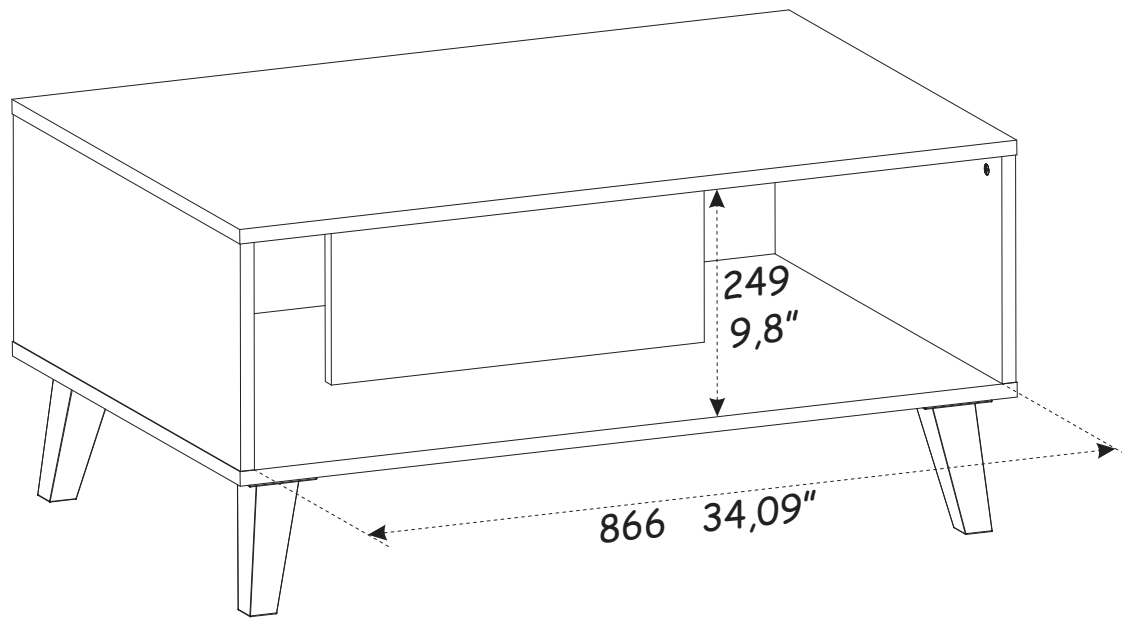





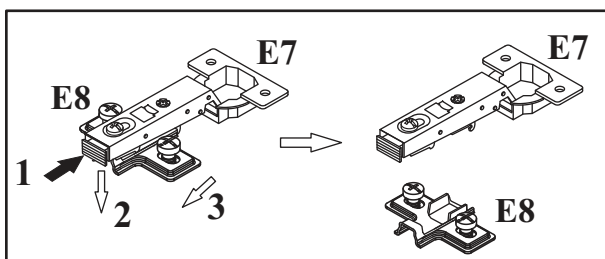
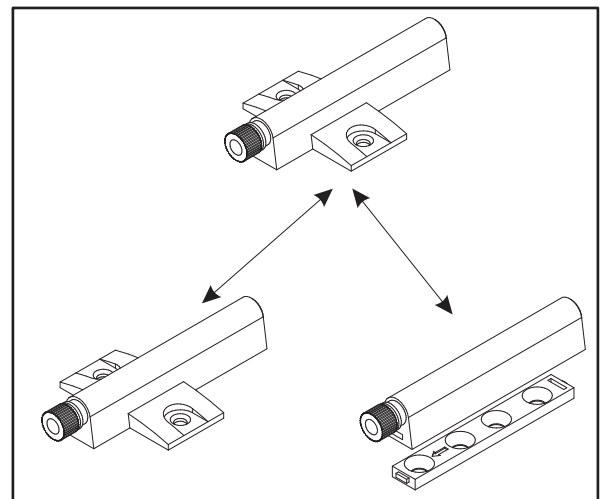
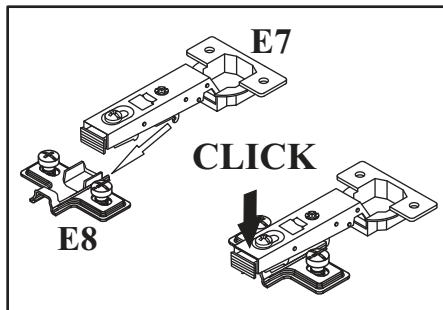
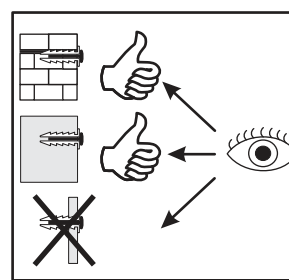
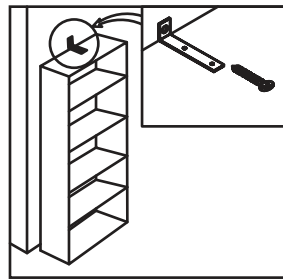
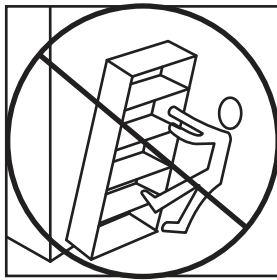
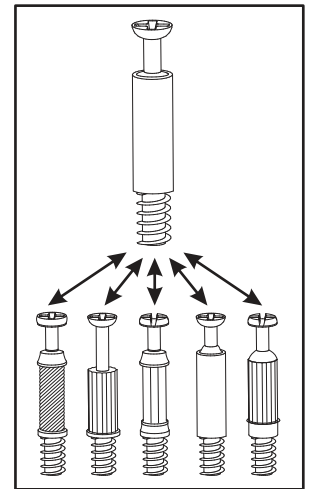
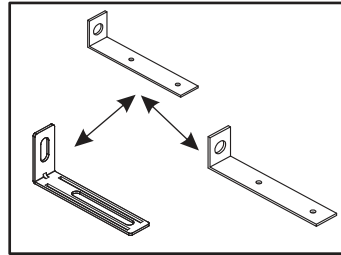
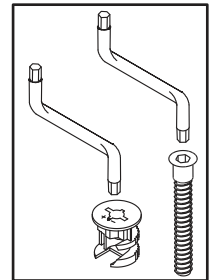
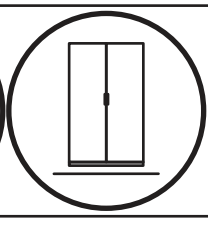
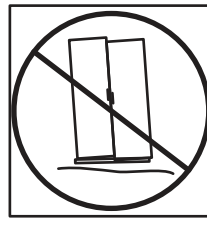
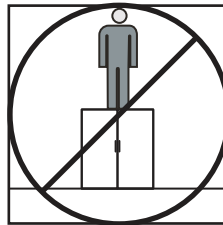
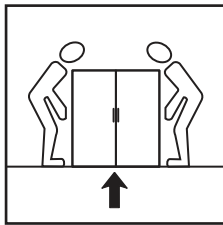
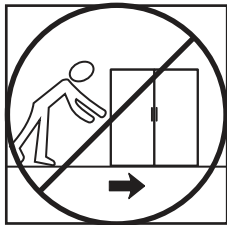
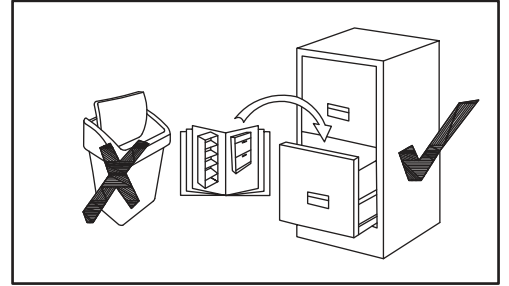
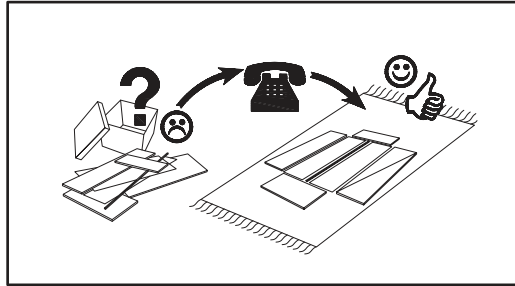
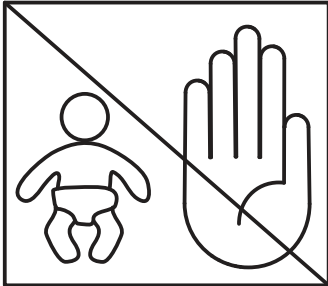
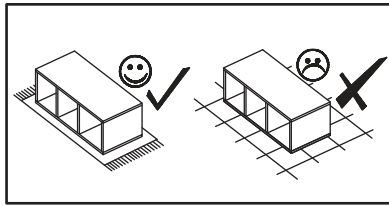
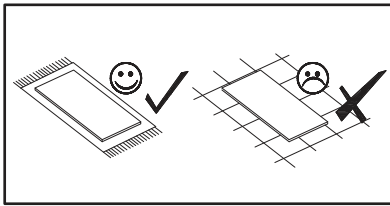



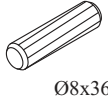

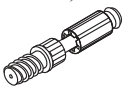

RAVENNA COFFEE TABLE

LEFT RIGHT





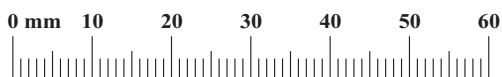
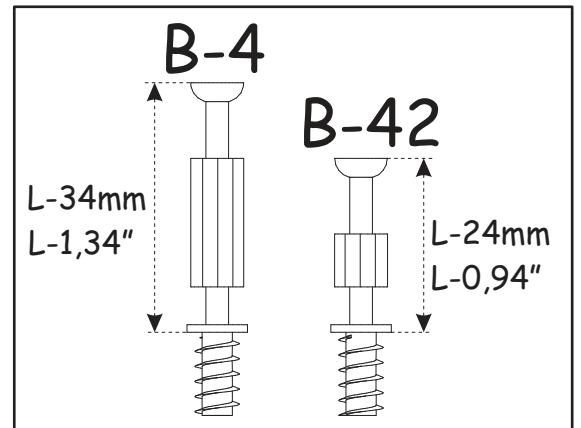

RAVENNA COFFEE TABLE

A1 x4  Ø8x36	Ø0,31"x1,42"	A11 x8  Ø5x30	Ø0,2"x1,18"	B4 x2  L-34mm	L-1,34"	B42 x6  L-24mm	L-0,94"	B5 x2  Ø15x12	Ø0,59"x0,47"	B52 x6  Ø12x12	Ø0,47"x0,47"
G5 x2 		G12 x6  Ø14		B11 x8  Ø7x50	Ø0,28"x1,97"	G4 x8 		ST23 x4 		D13 x16  USØ0,14"x0,79" USØ3,5x20	
G2 x1 											

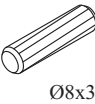

RAVENNA COFFEE TABLE

1

<b>B52</b>	Ø0,47"x0,47"	<b>A11</b>	Ø0,2"x1,18"	<b>A1</b>	Ø0,31"x1,42"	<b>B5</b>	Ø0,59"x0,47"
x6		x8		x4		x2	
	Ø12x12		Ø5x30		Ø8x36		Ø15x12

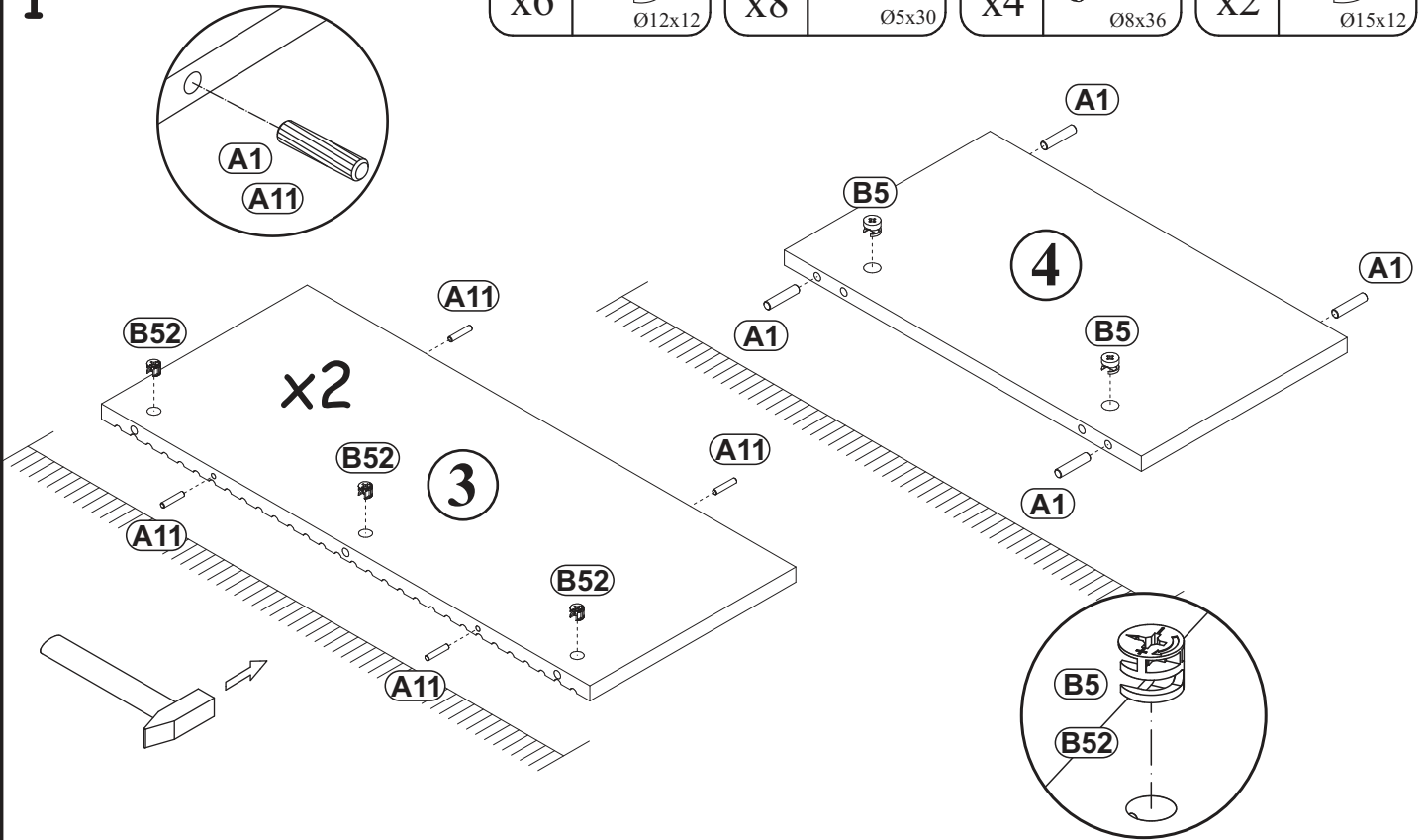

2

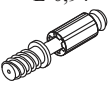
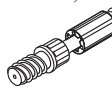
<b>B42</b>	L-0,94"	<b>B4</b>	L-1,34"
x6		x2	
	L-24mm		L-34mm

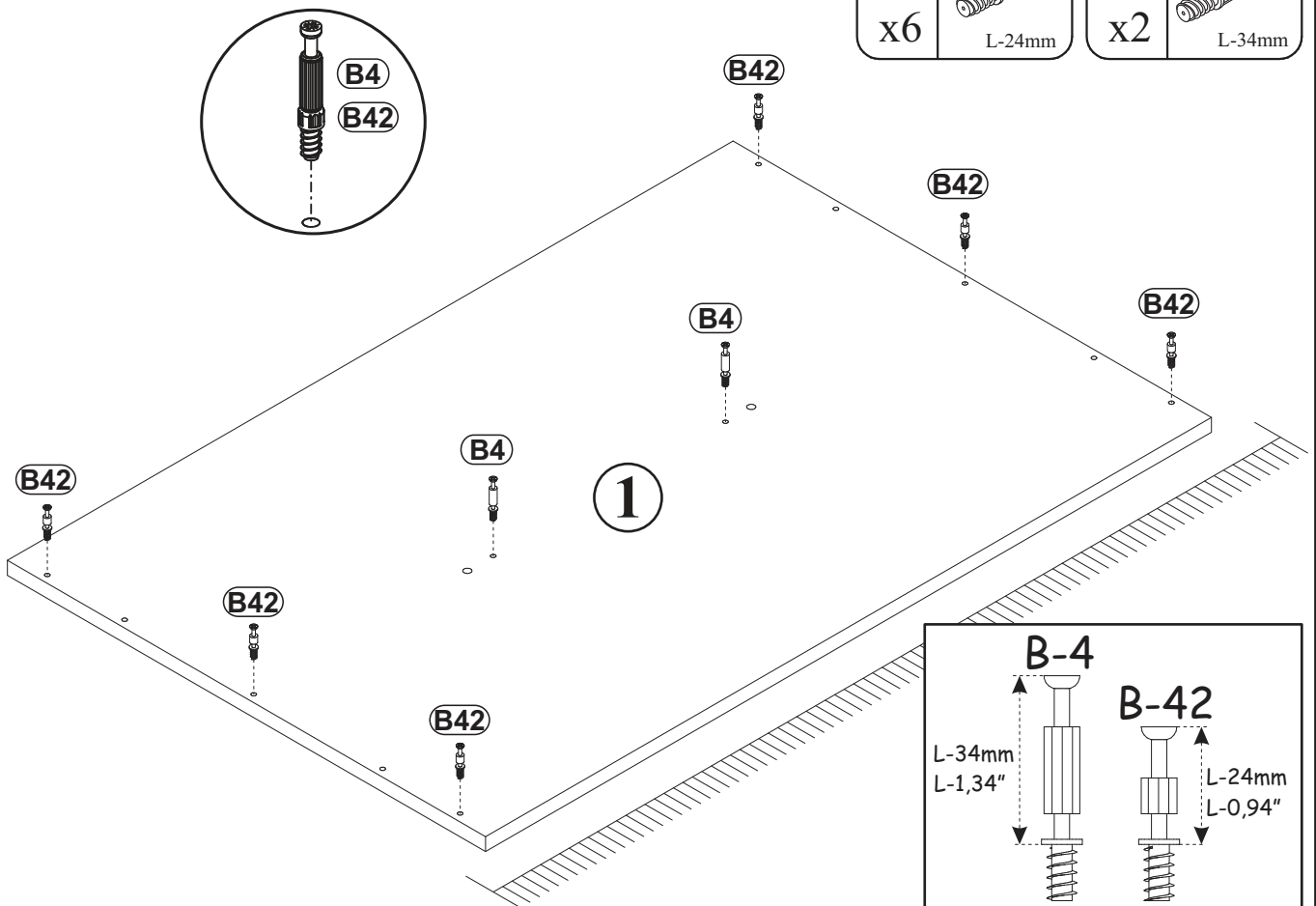

G12

x6

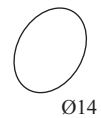

3

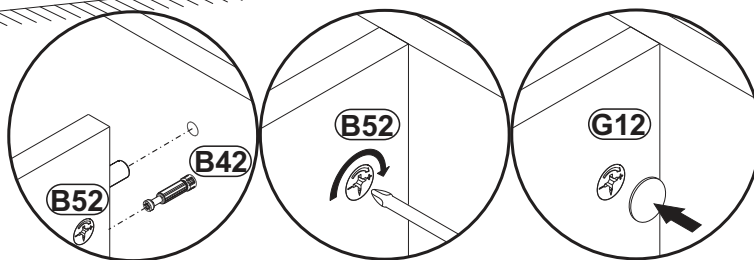
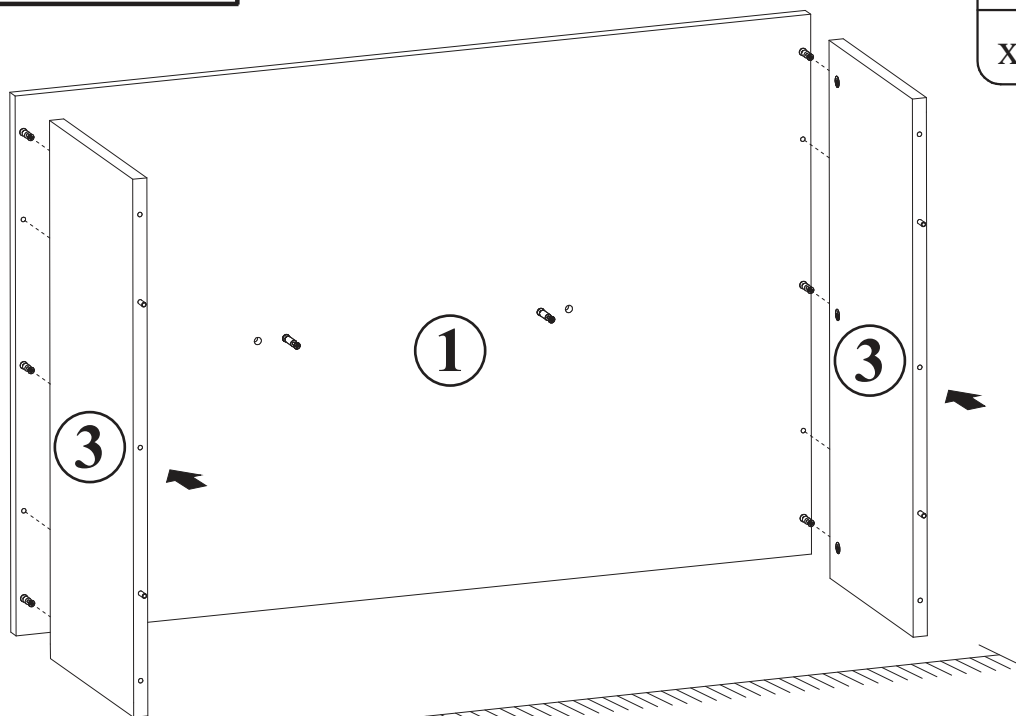

4

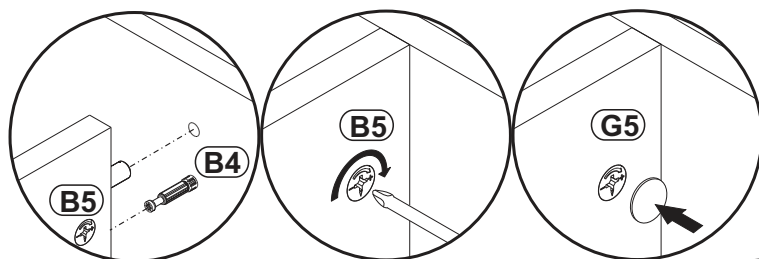

G5

x2

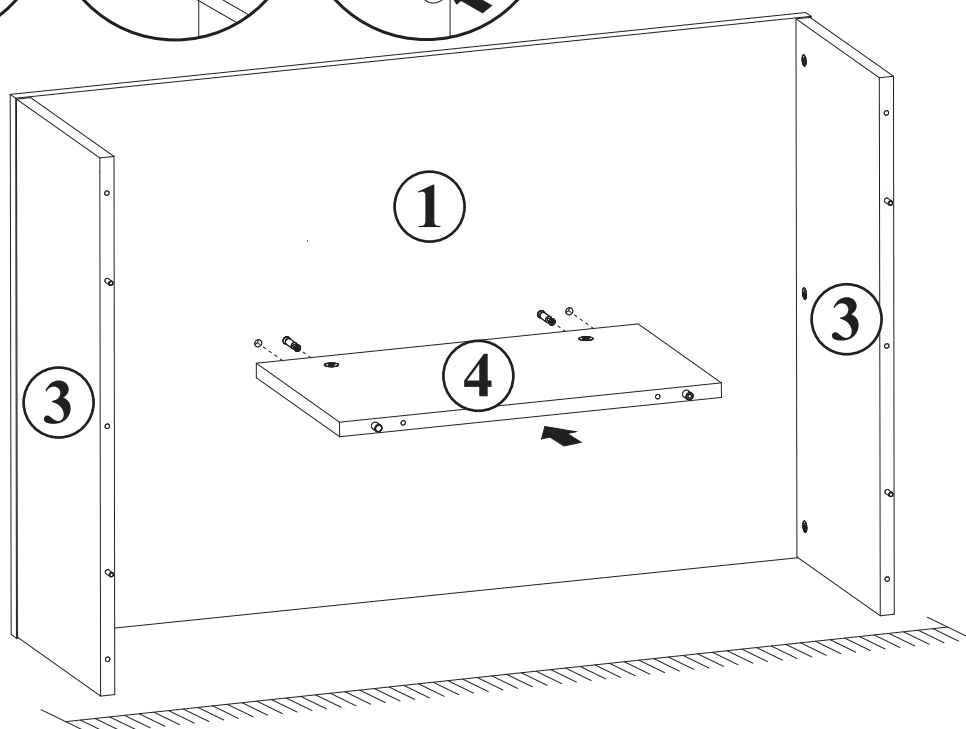

RAVENNA COFFEE TABLE

5

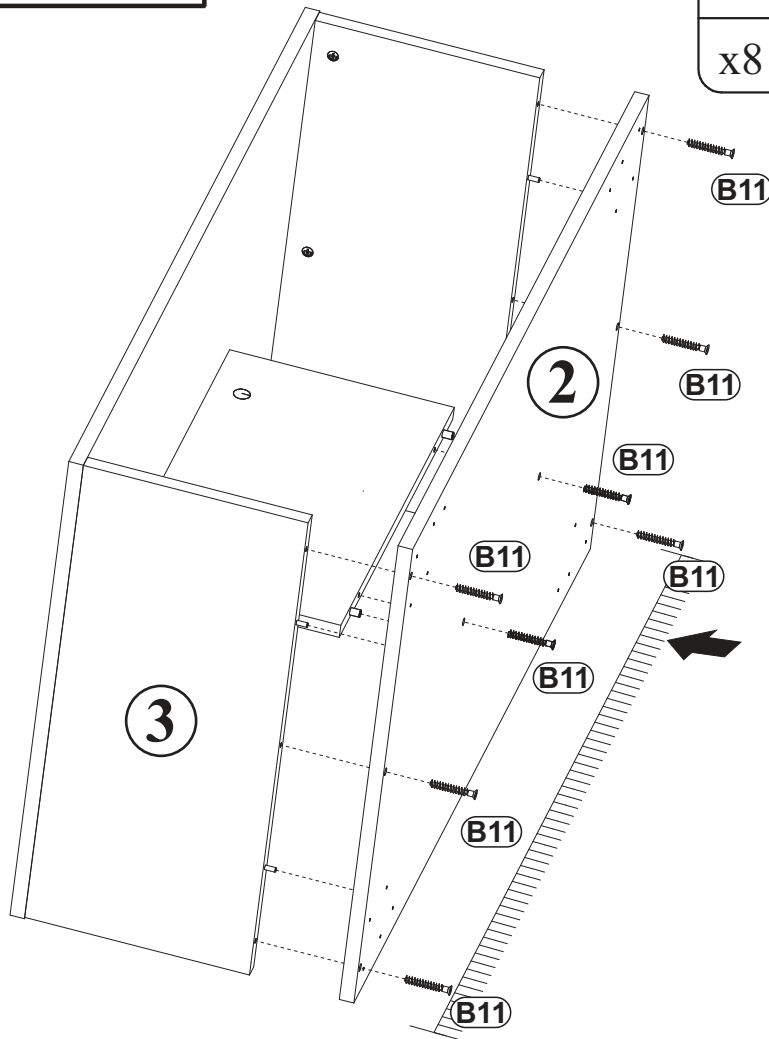

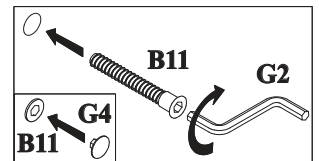

G4	
x8	

B11	
x8	$\varnothing 0,28'' \times 1,97''$ $\varnothing 7 \times 50$

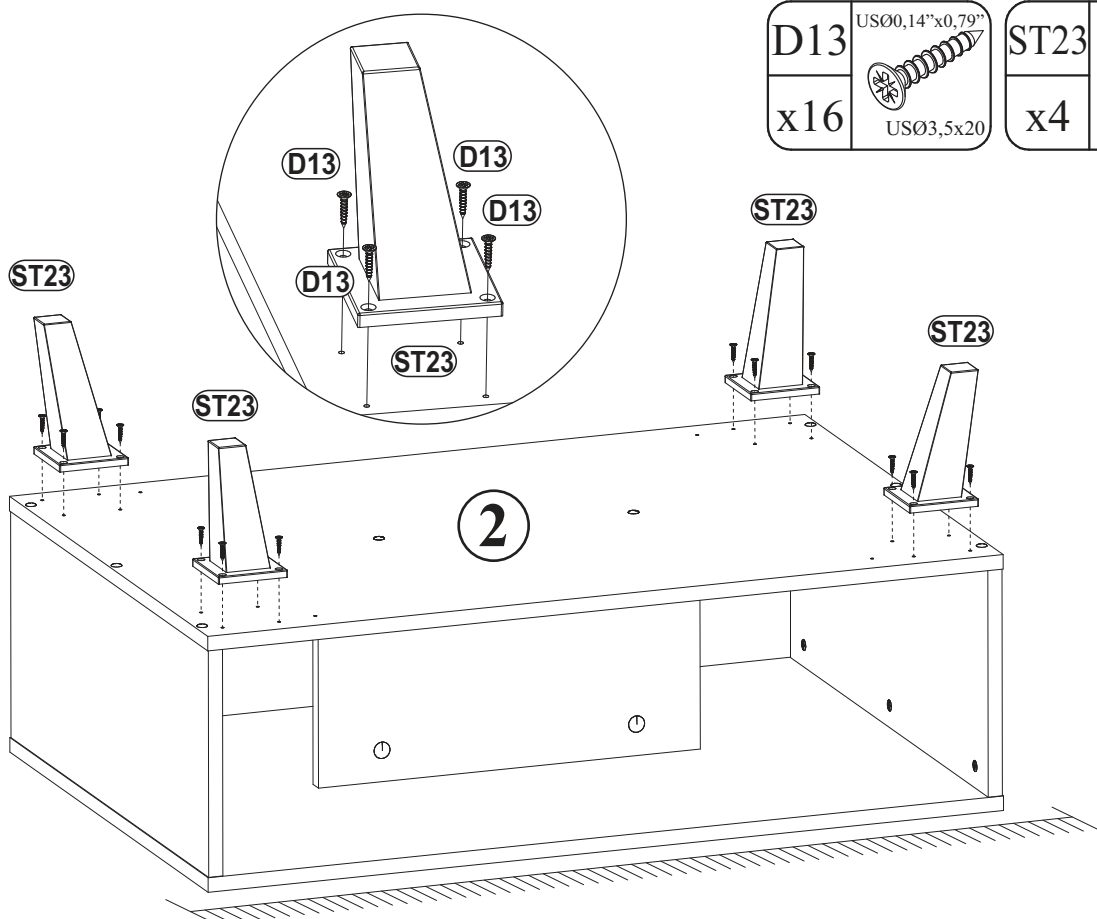

6



D13	
x16	$US\varnothing 0,14'' \times 0,79''$ $US\varnothing 3,5 \times 20$

ST23	
x4	

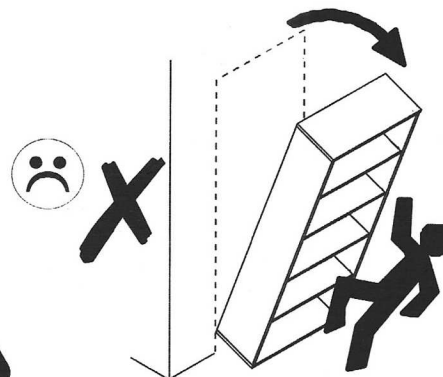
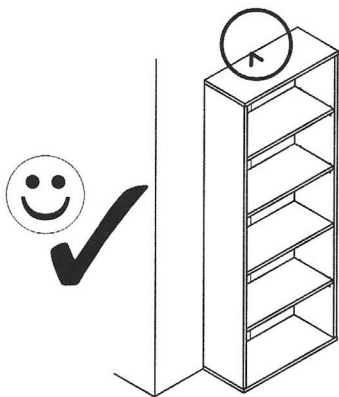

PL.

UWAGA! Mebel należy trwale zamocować do ściany, aby uniknąć ryzyka związanego z przewróceniem się mebla. W paczce znajdują się elementy mocujące odpowiednie wyłącznie do ścian betonowych lub z pełnej cegły. Jeśli Twoja ściana wykonana jest z innego materiału lub nie masz pewności co do budowy tej ściany, skonsultuj się w kwestii montażu ze specjalistą.

RU.

ПРИМЕЧАНИЕ! Эту мебель необходимо всегда прикреплять к стене, чтобы избежать рисков, связанных с переворотом мебели. В пакете находятся крепительные элементы, которые подходят исключительно к бетонным стенам или из целого кирпича. Если стена изготовлена из другого материала или Вы не уверены относительно строения стены, проконсультируйтесь относительно монтажа со специалистом.

I.

ATTENZIONE! Il mobile deve essere permanentemente fissato alla parete per evitare i rischi derivanti da un ribaltamento del mobile. La confezione contiene solo elementi di fissaggio adatti per pareti in calcestruzzo o in laterizio pieno. Se la vostra parete è realizzata in materiale diverso o avete dubbi sulla costruzione della parete, consultare uno specialista per un montaggio corretto.

EN.

WARNING! To prevent this furniture from tripping over, fix it to the wall permanently. The package includes fastening elements only suitable for concrete or full-brick walls. If your wall is made of a different material or you are unsure as to the construction of the wall, please consult a specialist regarding installation.

FR.

ATTENTION! Ce meuble doit être fixé en permanence au mur pour éviter les risques de chute. L'ensemble comprend des moyens de fixation adaptés uniquement aux murs de béton ou de brique. Si votre mur est fait d'un matériau différent ou si vous êtes incertain quant à la construction du mur, consultez un spécialiste.

HR.

NAPOMENAJE! Namještaj mora biti trajno pričvršćen za zid, kako bi se izbjegao rizik od njegova prevrtanja. U paketu se nalaze elementi za pričvršćivanje prikladni isključivo za betonske zidove ili punu ciglu. Ako je Vaš zid izrađen od drugog materijala ili niste sigurni od čega je napravljen Vaš zid, konzultirajte se sa stručnjakom u vezi sa montažom.

CN.

注意！本家具需要固定在墙上以免倒塌。  
本包所含有的固定部件仅适用于混凝土墙及整砖墙。  
欲使用在其他墙体或不确定墙体时，  
请向专家询问安装方式。

D.

ACHTUNG! Um alle mit dem Umkippen des Möbels verbundenen Risiken auszuschließen, muss das Möbel fest an der Wand verankert werden. Die im Paket enthaltenen Beschläge für die Wandbefestigung sind ausschließlich für Wände aus Beton oder Vollziegeln geeignet. Sollten die heimischen Wände aus anderem Baumaterial bestehen oder sollte es Zweifel in Hinsicht auf dieses Baumaterial geben, bitte eine Fachkraft zu Rate ziehen.

HU.

FIGYELEM! Rögzítse a bútorkat a falhoz, hogy elkerülje a bútor felborulásának kockázatát. A készletben kizárólag beton- vagy téglafalhoz használható kötőelemek találhatók. Ha a fal más anyagból készül, vagy ha nem tudja, milyen falak találhatók otthonában, forduljon szakemberhez.

CZ.

POZOR! Nábytek je nutné pevně připevnit ke zdi, abychom se vyhnuli riziku spojenému s jeho převrnutím. V balíčku se nacházejí připevňující prvky vhodné výhradně do betonových zdí nebo zdí z plných cihel. Pokud jsou Vaše zdi zhotoveny z jiného materiálu nebo si nejste jejich konstrukci jisti, konzultujte otázku montáže se specialistou.

E.

¡ATENCIÓN! El mueble debe ser fijado permanentemente a la pared para evitar el riesgo relacionado con el vuelco del mueble. En el paquete hay elementos de fijación adecuados solo para paredes de hormigón o de ladrillo entero. Si su pared está hecha de otro material o no está seguro sobre la construcción de esta pared, consulte el montaje con un especialista.

SK.

POZOR! Nábytok musí byť trvalo pripevnený k stene tak, aby sa zamedzilo riziku prevrátenia. V balíku sa nachádzajú upevňovacie komponenty výlučne pre betónové steny alebo steny z plnej tehly. Ak je Vaša stena z iného materiálu alebo ak si nie ste istí, z čoho je stena vyhotovená, vyžadajte si odbornú pomoc.

SLO.

POZOR! Pohišivo trajno pritrđite na steno, da preprečite tveganje, da se prevrne. V paketu so pritrđilni elementi, ki so ustržni izključno za betonske stene in za stene iz polne opeke. Če je vaša stena izdelana iz drugih materialov ali niste gotovi glede konstrukcije stene, se o montaži posvetujte s strokovnjakom.



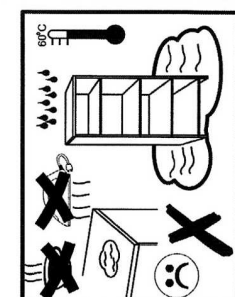
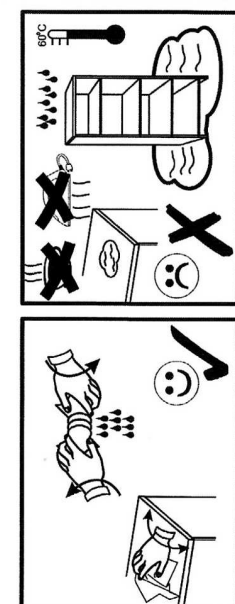
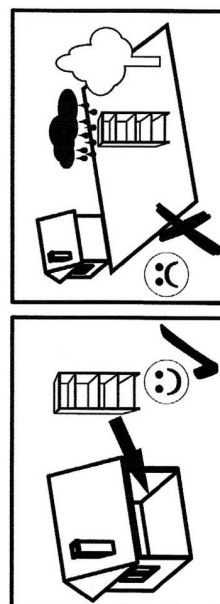
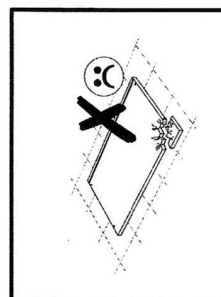
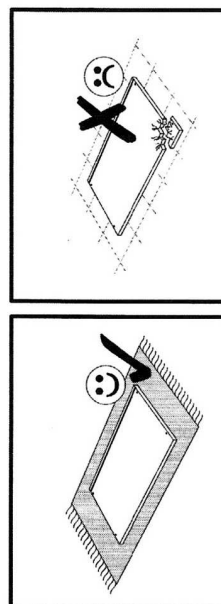
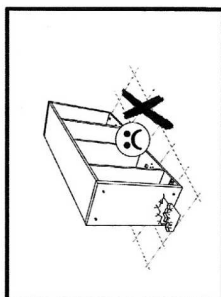
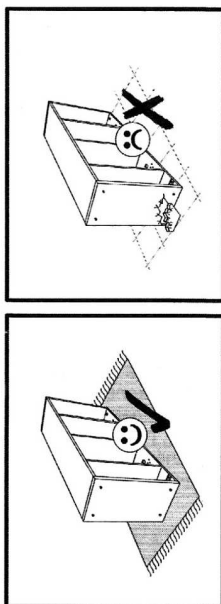
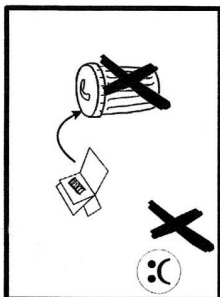
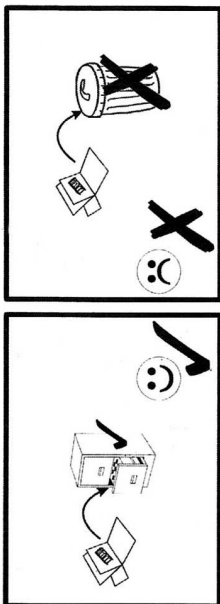
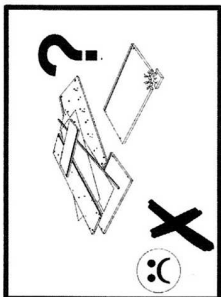
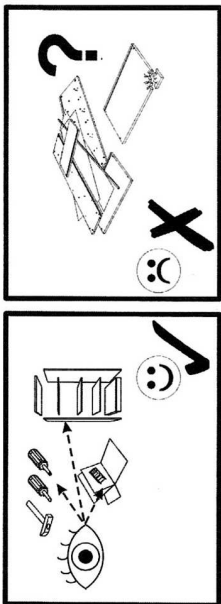

**D: ALLGEMEINE HINWEISE FÜR MÖBEL AUS HOLZ UND HOLZWERKSTOFFE: MELAMIN, LAMINAT, ARMATURENBRETT**  
Zu reinigen, verwenden Sie ein feuchtes Tuch. Verwenden Sie nur Wasser oder ein mildes Reinigungsmittel. Wischen Sie mit einem Tuch trocken.

**GB: GENERAL INSTRUCTIONS FOR FURNITURE OF WOOD AND WOOD MATERIALS: MELAMINE, LAMINATE, DASHBOARD**  
To clean, use a damp cloth. Use only water or a mild detergent. Wipe dry with a cloth.

**ES: INSTRUCCIONES GENERALES PARA MUEBLES DE MADERA Y MATERIALES: MELAMINA, LAMINADO, TABLERO DE INSTRUMENTOS**  
Para limpiar, utilice un paño húmedo. Utilice sólo agua o un detergente suave. Seque con un paño

**FR: INSTRUCTIONS GENERALES DE MEUBLES DE MATÉRIEAUX DE BOIS ET: MÉLAMINÉS, STRATIFIÉS, TABLEAU DE BORD**  
Pour nettoyer, utilisez un chiffon humide. Utilisez seulement de l'eau ou un détergent doux. Essuyez avec un chiffon.

**CZ: VŠEOBECNÉ POKYNY PRO NÁBYTEK ZE DŘEVA A DŘEVĚNÝCH MATERIÁLŮ: MELAMINE, LAMINÁT, DASHBOARD**  
K čištění použijte vlhký hadřík. Používejte pouze vodu nebo jemným čistícím prostředkem. Vyřete do sucha hadříkem.

**PL: OGÓLNE INSTRUKCJE DOTYCZĄCE MEBLI Z DREWNA ORAZ MATERIAŁÓW DREWNOPOCHODNYCH: MELAMINA, LAMINAT, OKLEINA**  
Do czyszczenia należy używać wilgotnej ściereczki. używać wyłącznie wody lub delikatnego detergentu. Wycierać do sucha ściereczką.

**HU: A BŰTOR ÁLTALÁNOS FAANYAGOK ÉS FAIPARI ANYAGOK: MELAMIN, LAMINÁT, MŰSZERFAL**  
A tisztításhoz használjon egy nedves ruhával. Csak vizet vagy enyhé tisztítószerrel. Töröld szárazra egy ronggyal.

**HU: A BŰTOR ÁLTALÁNOS FAANYAGOK ÉS FAIPARI ANYAGOK: MELAMIN, LAMINÁT, MŰSZERFAL**  
A tisztításhoz használjon egy nedves ruhával. Csak vizet vagy enyhé tisztítószerrel. Töröld szárazra egy ronggyal.

**SK: VŠEOBECNÉ POKYNY PRO NÁBYTEK ZE DŘEVA A DŘEVĚNÝCH MATERIÁLŮ: MELAMINE, LAMINÁT, DASHBOARD**  
Na čistenie použite vlhkú handričku. používajte iba vodu alebo jemným čistiacim prostriedkom. Vytrite dosucha handričkou.

**RU: ОБЩИЕ ПРАВИЛА ДЛЯ МЕБЕЛИ ДРЕВЕСИНЫ И ДРЕВЕСНЫХ МАТЕРИАЛОВ: МЕЛАМИН, ЛАМИНАТ, ПАНЕЛЬ**  
Для очистки используйте влажную ткань. Используйте только воду или мягкое моющее средство. Протрите сухой тряпкой.

**IT: ISTRUZIONI GENERALI PER MOBILI DI LEGNO E LEGNO MATERIALI: MELAMINICO, LAMINATO, CRUSCOTTO**  
Per la pulizia, utilizzare un panno umido. Utilizzare solo acqua o un detergente neutro. Asciugare con un panno.

**RO: INSTRUCȚIUNI GENERALE DE MOBILIER DE LEMNOASA ȚI MATERIALE LEMNOASE: PAL, LAMINAT, TABLOU DE BORD**  
Pentru a curăți, folosiți o cârpă umezită. Folosiți numai apă sau un detergent slab. Stergeți cu o cârpă.

**TR: AHŞAP VE AHŞAP MALZEMELERİN MOBİLYA İÇİN GENEL BİLGİLER: MELAMİN, LAMİNAT, PANELE**  
Temizlemek için, nemli bir bez kullanın. Sadece su veya veya hafif bir deterjan kullanın. Bir bez ile kurulayın.

**NL: ALGEMENE RICHTLIJNEN VOOR MEUBEL EN HOUT EN HOUTPRODUCTEN MATERIALEN: MELAMINE, LAMINAAT, DASHBOARD**  
Schoon te maken, gebruikt u een vochtige doek. Gebruik alleen water of een mild schoonmaakmiddel. Veeg met een doek droog.

**PL: Komplementowanie akesorii oraz proces pakowania**  
odbywa się pod nadzorem kontroli jakości oraz monitoringu.

**EN: Complementing the accessories and the packaging process is carried out under the supervision of quality control and monitoring.**

**DE: Die Ergänzung des Zubehörs und des Verpackungsprozesses erfolgt unter der Aufsicht der Qualitätskontrolle und -überwachung.**

**FR: Le complément des accessoires et du processus d'emballage s'effectue sous la supervision d'un contrôle et d'une surveillance de la qualité.**

